

# GL-SP30 User Manual

Thanks for your choice of LED SP30 series products. Please ensure that you install and use the product according to the below directions to enable the correct implementation and normal functioning of the LED product. Should you not follow these directions, you will not be compensated in accordance with the warranty. We will not take any responsibility from the improper use and implementation of the product, and for any associated damage caused by such irresponsible and negligent actions.



## CAUTION

1. The "Warranty Period" is two (2) years. We will warrant free repair or replacement services if the product fails or becomes defective during normal use within the prescribed warranty period. Please send back the product to our company or contact your local distributors for further directions.
2. Do not change or tamper with any internal electric circuits or add in any wires or cables for any reason.
3. Do not change the mechanical design, circuit specifications, or components; do not add any other devices as this may cause the product to short circuit or may create other unforeseen risks.
4. Keep the lamp set in a dry environment in order to avoid any electricity leakage.
5. To avoid electrical shocks and possible malfunction, please do not insert objects of any nature into the LED product.
6. For further information, please contact us.

**CAUTION**  
CLASS 2 LED LIGHT  
DO NOT STARE INTO THE BEAM

## Installation process

Please get professional installation personnel to set up the fixture.

1. Before installation, please turn off the power switch for the existing bulb.

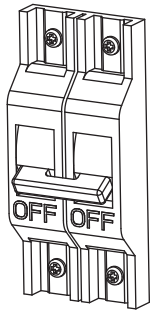

2. Please make sure that the specifications of the power connector and the output voltage are compatible to the LED fixture used.



3. At the rear side of the LED fixture, please connect the Live (L) and Neutral (N) terminal are used for connecting to power output. Please follow the standard process to connect them accordingly and do insulation on both terminal respectively.

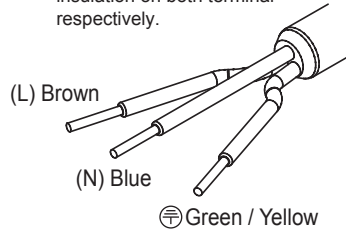

4. Screw the LED fixture tight onto a wall or a stand and adjust the angle in accordance with individual needs.

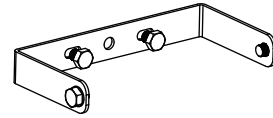

5. Please plug the unit into an appropriate power socket and turn the power on. If the lamp does not work, please repeat steps 1-4 until it does work.

## Specifications

Optical		
Model No.	GL-SP30-WW (Warm White)	GL-SP30-CW (Cool White)
CCT (Typical)	3000 K	6000 K
Luminous Flux (lm)	1,200 lm	1,700 lm
Typical Luminous Efficacy	32 lm / W	45 lm / W
CRI (Ra)	> 80	> 75
Beam Angle	30° / 60° (Optional)	
Mechanical and Dimension		
Outline Dim.	313 × 223 × 92 (mm)	
Net. Weight	3.5 (Kgs)	
Cover	Clear	
Electrical		
Typical Power consumption	38 W	
Power Factor	> 0.95 for 115V AC; > 0.85 for 230V AC	
Input Voltage	100 – 240V AC	
Temperature Condition		
Operating Temperature	-20 °C – +40 °C	
Storage Temperature	-40 °C – +85 °C	

## GL-SP30 Outlook

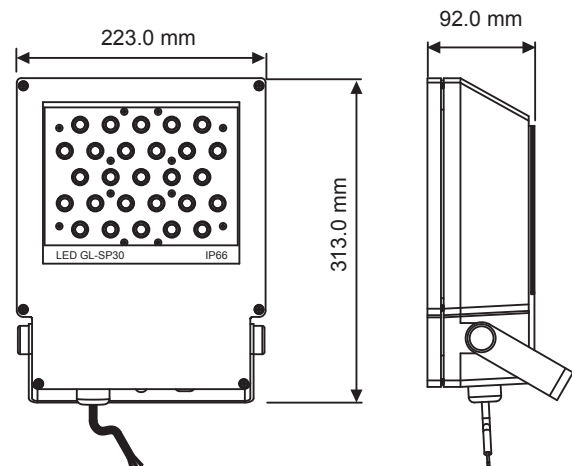

# Candle Power Distribution Curve(30W/3M)

## SP30-CW 30°

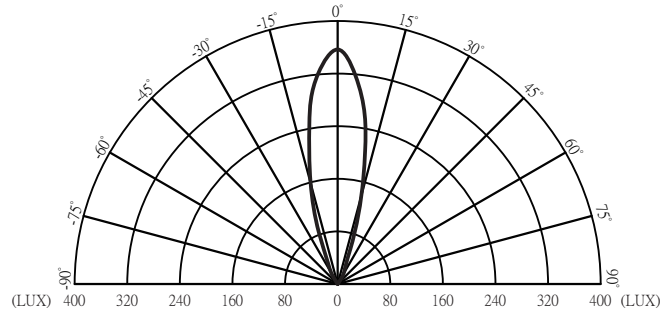
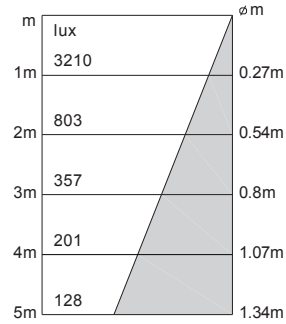

## SP30-CW 60°

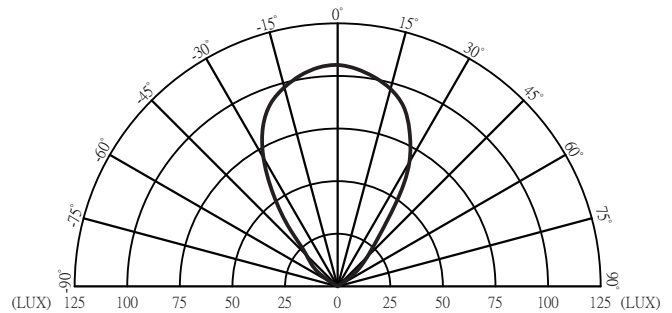
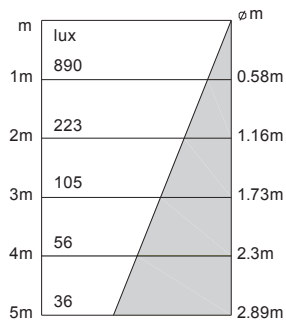

## SP30-WW 30°

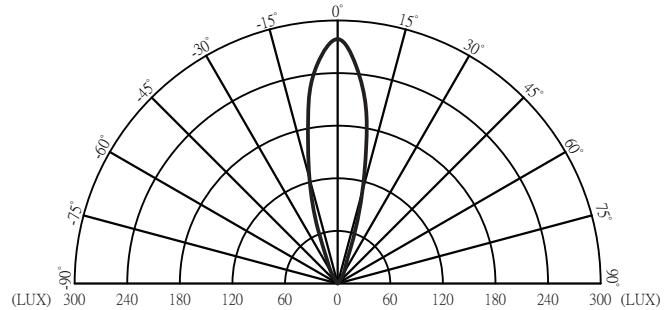
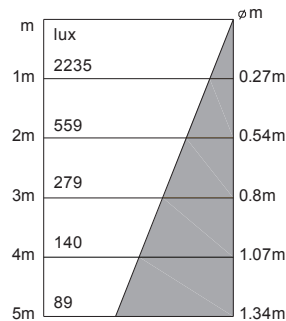

## SP30-WW 60°

